

Symaro™

## Duct Temperature Sensors QAM21...

Passive sensors for acquiring the air temperature in air ducts.

### Use

The duct temperature sensors are for use in ventilation and air conditioning plants as:

- Supply or extract air temperature sensors
- Limit sensors, e.g. for minimum limitation of the supply air temperature
- Reference sensors, e.g. for shifting the room temperature as a function of the outside temperature
- Measuring sensors, e.g. for measured value indication or for connection to a building automation and control system

### Type summary

Type reference	Probe length	Mounting clamps	Sensing element
<b>QAM2110.040</b>	0,4 m	no	Pt 100
<b>QAM2112.040</b>	0,4 m	no	Pt 1000
<b>QAM2112.200</b>	2,0 m	4 pcs.	Pt 1000
<b>QAM2120.040</b>	0,4 m	no	LG-Ni 1000
<b>QAM2120.200</b>	2,0 m	4 pcs.	LG-Ni 1000
<b>QAM2120.600</b>	6,0 m	6 pcs	LG-Ni 1000
<b>QAM2130.040</b>	0,4 m	no	NTC 10k

**Accessories**  
(Spare parts)

Name	Type reference
Capillary tube clamp for the QAM2120.200 and QAM2120.600 (6 pieces)	<b>AQM63.3</b>
Mounting flange	<b>AQM63.0</b>

**Ordering and delivery**

When ordering, please give name and type reference, e.g.:

Duct temperature sensor **QAM2120.040**

The sensor is supplied complete with mounting flange AQM63.0 and, if required, mounting clamps AQM63.3.

**Equipment combinations**

All systems or devices capable of acquiring and handling the sensor's passive output signal.

**Function**

The sensor acquires the air temperature via its sensing element whose resistance changes as a function of the temperature. The signal is delivered to a suitable controller for further handling.

**Sensing elements**

LG-Ni 1000

Characteristic:

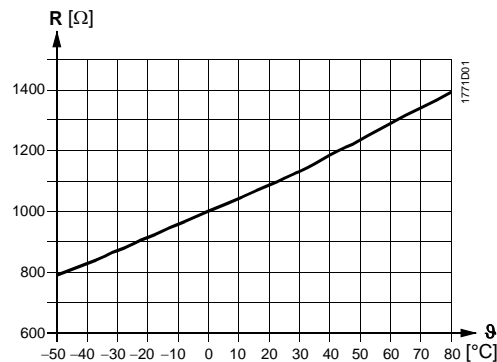

Accuracy:

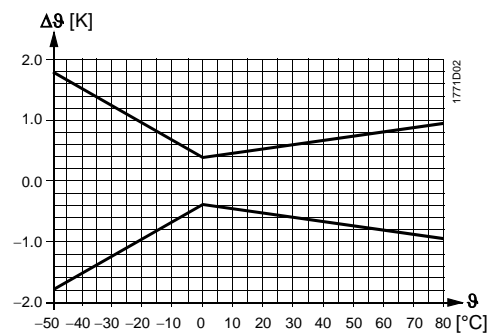

Pt 100 (class B)

Characteristic:

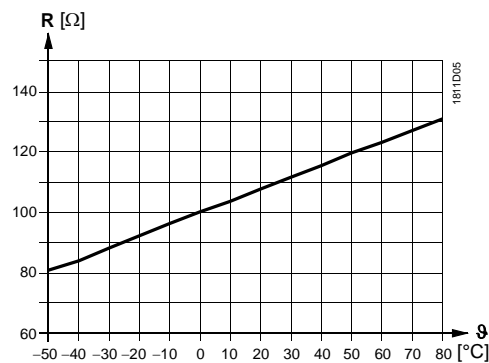

Accuracy:

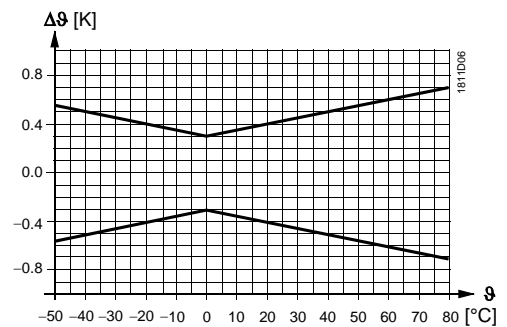

Pt 1000 (class B)

Characteristic:

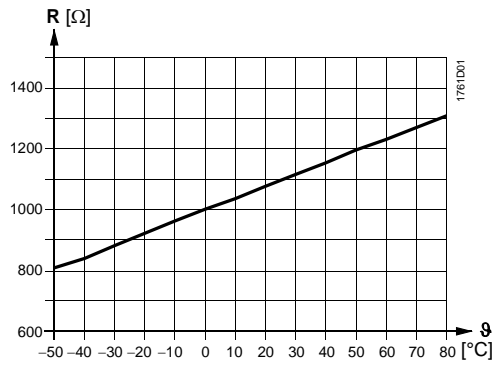

Accuracy:

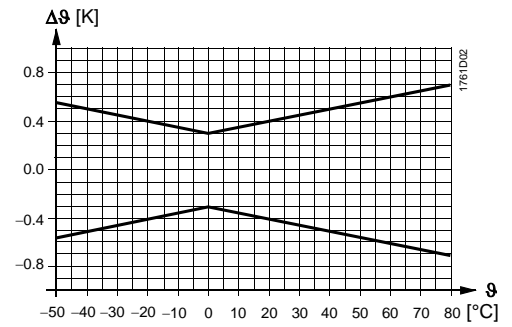

NTC 10k

Characteristic:

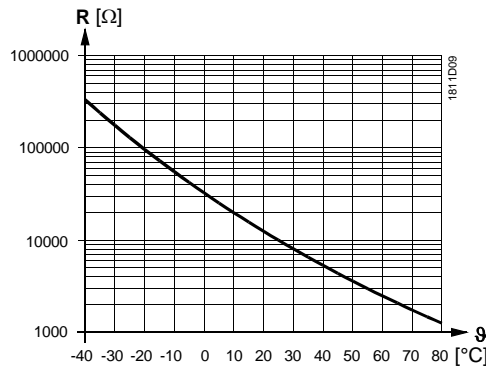

Accuracy:

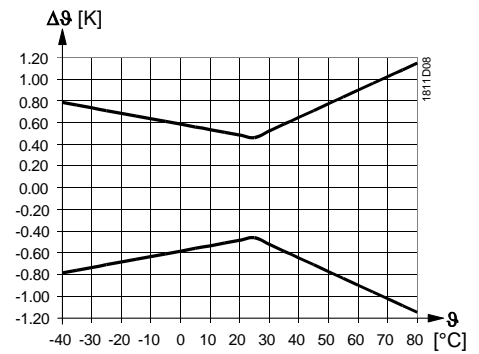

Legend

R Resistance value in Ohm  
 $\theta$  Temperature in degrees Celsius  
 $\Delta\theta$  Temperature differential in Kelvin

## Mechanical design

The duct temperature sensor consists of the following components:

- Two-sectional plastic housing comprised of base with connection terminals and removable cover (snap-on design)
- Fully active, flexible probe with sensing element which acquires the average temperature

The connection terminals can be accessed after removing the cover. Cable entry is made via a grommet which, if required, can be replaced by a cable entry gland M16 (IP 54).

After fitting the mounting flange, the sensor can be installed in 6 different immersion positions so that the sensor housing is always located outside the insulation for layers up to 70 mm. The probe with a length of 2 or 6 m is to be fitted across the air duct with the help of the mounting clamps supplied with the sensor.

## Mounting notes

### Mounting location

- *For supply air temperature control:* Downstream from the fan, if the fan is located after the last air handling unit. Otherwise, after the last air handling unit with a minimum distance of 0.5 m
- *For extract air temperature control:* Always upstream of the extract air fan
- *As a limit sensor for the supply air temperature:* As close as possible to the air outlet into the room
- *For dew point control:* Immediately after the spray trap of the air washer

Manually bend the probe so that it lies diagonally across the duct or in equally spaced windings across the entire duct cross-section. The probe must not touch the duct wall.

The sensor is supplied complete with Mounting Instructions.

### Mounting positions

*permitted:*



*not permitted:*



### Mounting examples

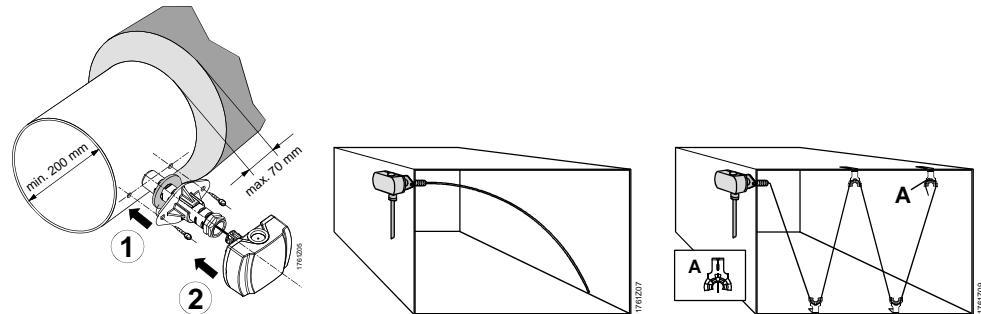

## Disposal



The device is considered electrical and electronic equipment for disposal in terms of the applicable European Directive and may not be disposed of as domestic garbage.

- Dispose of the device via the channels provided for this purpose.
- Comply with all local and currently applicable laws and regulations.

## Technical data

Functional data	Operating range	-40...+80 °C for NTC type -50...+80 °C other types
	Sensing element	refer to "Type summary"
	Probe	
	Length	Refer to "Type summary"
	Min. bending radius	10 mm
	Time constant	30 s at 2 m/s
	Dead time	< 1 s
Degree of protection	Measuring accuracy	Refer to "Function"
	Protection class	III according to EN 60730-1
	Protection degree of housing With cable entry gland M 16 x 1.5	IP42 according to EN 60529 IP54 according to EN 60529 (not included as standard)
Electrical connections	Screw terminals for	1 x 2.5 mm <sup>2</sup> or 2 x 1.5 mm <sup>2</sup>
	Cable entry	
	Grommet	For 5.5...7.2 mm dia. cable
	Cable entry gland	M 16 x 1.5 can be fitted
Directives and Standards	Perm. cable lengths	refer to Data Sheet of the relevant controller
	Product standard	EN 60730-1 Automatic electrical controls for household and similar use
	UL	UL 873, <a href="http://ul.com/database">http://ul.com/database</a>
	EU Conformity (CE)	CE1T1761xx *)
Environmental conditions	Operation	To IEC 60721-3-3
	Climatic conditions	class 3K5
	Temperature (housing)	-40...+70 °C
	Humidity (housing)	5...95 % r. h.
	Transport	To IEC 60721-3-2
	Climatic conditions	Class 2K3
Temperature	-25...+70 °C	
Humidity	<95 % r. h.	
Mechanical conditions	class 2M2	
Materials and colors	Probe	Copper, polyolefine
	Base	Polycarbonate, RAL 7001 (silver-grey)
	Cover	Polycarbonate, RAL 7035 (light-grey)
	Mounting flange	PA 66 (black)
	Clamps	PA-GF 35 (black)
	Packaging	Corrugated cardboard
Weight	Incl. packaging	
	QAM2110.040	Ca. 0,15 kg
	QAM2112.040	Ca. 0,15 kg
	QAM2112.200	Ca. 0,3 kg
	QAM2120.040	Ca. 0,15 kg
	QAM2120.200	Ca. 0,30 kg
	QAM2120.600	Ca. 0,53 kg
	QAM2130.040	Ca. 0,15 kg

\*) The documents can be downloaded from <http://siemens.com/bt/download>.

## Internal diagram

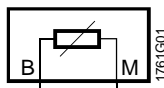

The internal diagram is identical for all types of duct temperature sensors covered by this Data Sheet.

The connecting wires are interchangeable.

## Dimensions

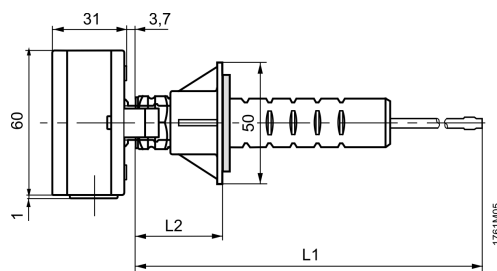
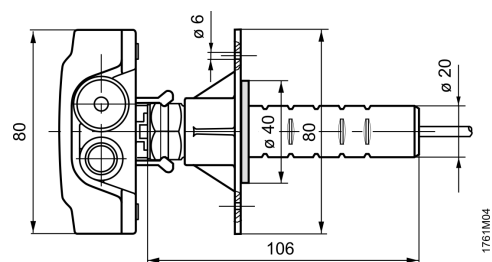

Typ

Typ	L1	L2	
		max.	min.
<b>QAM2130.040</b>	400	97	37
<b>QAM2110.040</b>	400	97	37
<b>QAM2120.040</b>	400	97	37
<b>QAM2112.040</b>	400	97	37
<b>QAM2112.200</b>	2000	97	37
<b>QAM2120.200</b>	2000	97	37
<b>QAM2120.600</b>	6000	97	37

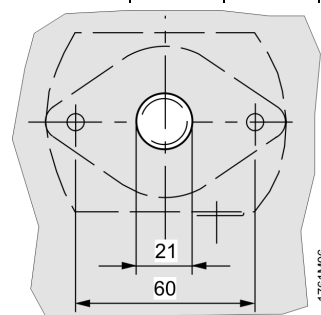

Drilling plan

Dimensions in mm

Published by:  
 Siemens Switzerland Ltd.  
 Building Technologies Division  
 International Headquarters  
 Gubelstrasse 22  
 6301 Zug  
 Switzerland  
 Tel. +41 58-724 24 24  
[www.siemens.com/buildingtechnologies](http://www.siemens.com/buildingtechnologies)

© Siemens Switzerland Ltd 2004  
 Delivery and technical specifications subject to change